

IR LED CAMERA

TEC-S45QLS2/DV36

600TVL / D-WDR / TDN / 45 IR LED CAMERA



IP66



- FEATURES -

- 1/3" SONY High-Resolution Super HAD II CCD
- 600TV Lines Horizontal Resolution
- Excellent Low Light Sensitivity of 0.3Lux/F1.2
- 45ea IR LED (Visibility Range : 100~120m)
- True Day & Night
- IR Smart
- Digital WDR : Digital Wide Dynamic Range
- DNR : Digital Noise Reduction
- HLC : High Light Compensation
- Blemish Compensation : 64 Points
- Lens Shading
- Motion Detection
- Privacy
- Built-in OSD Controller
- DC Varifocal ICR Lens f=3.6~16.0mm
- Fan Built-in
- IP66 Weatherproof Type
- Split Glasses for IR Reflection
- Adjustable Lens without Opening Case
- Video Looping Out Connector for Easy Installation

Option : Dual Voltage (DC 12V / AC 24V) / Heater (AC 24V Only)



1/3 SONY SUPER HAD II CCD

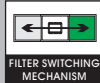

FILTER SWITCHING MECHANISM



DAY & NIGHT



DIGITAL WDR DIGITAL WIDE DYNAMIC RANGE



DNR DIGITAL NOISE REDUCTION



HLC HIGH-LIGHT COMPENSATION



AUTO IRIS



3.6-16.0mm VARIFOCAL LENS



45 IR LED



IP 66



DC 12V

- DIMENSION -

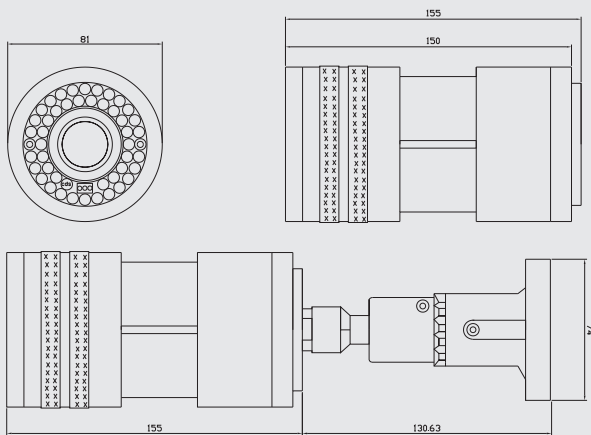

- SPECIFICATIONS -

TEC-S45QLS2/DV36		
Signal Format	NTSC	PAL
Horizontal Resolution	600TV Lines	
Image Sensor	1/3" SONY High-Resolution Super HAD II CCD	
Total Pixels	811(H) x 508(V)	795(H) x 596(V)
Effective Pixels	768(H) x 494(V)	752(H) x 582(V)
Scanning System	2:1 Interlace	
Synchronization	Internal	
Scanning Frequency	15.734 KHz(H), 59.94 Hz(V)	15.625 KHz(H), 50.00 Hz(V)
Video Output	CVBS : 1.0Vp-p/75Ω	
Min. Illumination	0.3Lux/F1.2	
Electronic Shutter	1/60 ~ 1/100,000 sec	1/50 ~ 1/100,000 sec
Iris Control	DC	
Signal to Noise Ratio	52dB (AGC Off, Weight On)	
Backlight Compensation	BLC / HLC / OFF	
White Balance	ATW1 (2,500°K ~ 9,500°K) / ATW2 (2,000°K ~ 11,000°K) / MANUAL / INDOOR / OUTDOOR	
Gain Control	LOW / HIGH / OFF	
DNR	ON / OFF (Level Adjustable)	
Day & Night	AUTO / COLOR / BW / EXT	
IR Control	ON / OFF (IR Smart)	
Digital WDR	ON / OFF	
Motion Detection	ON / OFF (4 Zone)	
Privacy	ON / OFF (8 Zone)	
Horizontal Mirror	ON / OFF	
Blemish Compensation	64 Points (Auto)	
Lens Shading	ON / OFF	
Parking Line	User Setting (LT, LB, RT, RB, F, N, T)	
OSD	Built-in (English, Chinese)	
Lens	DC Varifocal ICR Lens f=3.6~16.0mm	
LED Quantity	45 EA	
Input Voltage	DC 12V (±10%)	
Power Consumption	LED Off : Max. 3.8W / LED On : Max. 4.4W	
Operating Temp/Hum	Temperature : -10°C ~ +50°C / Humidity : 30% ~ 80% RH	
Dimension	81(Ø) x 155(D)mm	
Weight	Approx. 1.2kg (W/Bracket & Sunshield)	

- CONTROLLER -

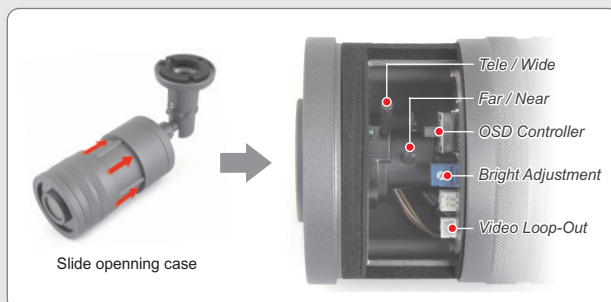

Slide opening case

In accordance with customers' request and OSD controller's option, the specifications can be fixed or changed without notice.